



Peelers Vegetable Peeler, 5kg with abrasive plate, removable chamber & filter

ITEM # _____

MODEL # _____

NAME # _____

SIS # _____

AIA # _____



603498 (DT5EFB)

5 kg vegetable peeler,
abrasive plate and
incorporated filter basket

Short Form Specification

Item No. _____

Can be placed on a worktop. 5 kg, removable stainless steel peeling chamber contains the abrasive plate which also serves as a container for carrying the vegetables. Vegetables can be loaded directly into the peeling chamber, away from the machine. Easily assembled onto the base, with the drive shaft fitting into the centre of the plate. The transparent cover closes the cylinder during the peeling operations. Timer pre-set to 3 minutes. Peeling speed: 305 rpm. Removable water inlet, on the cover, designed to serve as a spray for cleaning the machine. The electronic controls and the motor of the peeler have IP55 protection. Optional drying basket.
Supplied with abrasive plate and integrated/removable filter basket.

Main Features

- Removable stainless steel peeling chamber to contain the abrasive plate which also serves as a container to carry the vegetables.
- Supplied with an abrasive plate as standard.
- Removable water inlet, clipped to the cover, designed to serve as a spray to clean the machine.
- Red OFF, green ON buttons.
- Integrated built-in filter device, removable for cleaning.
- Peeling time on timer preset to 3 minutes
- Easily fits onto the base, with the drive shaft fitting into the center of the plate.
- Dishwasher safe removable parts.
- Transparent lid to close the cylinder during peeling operations.
- Unit can be placed on a work top.
- Productivity suitable for 30-100 meals per service.

Construction

- 1 speed: 305 rpm.
- IP55 waterproof control buttons.
- Transparent BPA free cover.

Included Accessories

- 1 of Filter basket for 5 kg vegetable peeler PNC 653314
- 1 of Abrasive plate for 5/8 kg vegetable peeler PNC 653316

Optional Accessories

- Filter basket for 5 kg vegetable peeler PNC 653314
- Drying basket for 5 kg vegetable peeler (only T5E) PNC 653315
- Abrasive plate for 5/8 kg vegetable peeler PNC 653316
- Stainless steel table for 5 and 8 kg vegetable peelers PNC 653496

APPROVAL: _____



Peelers Vegetable Peeler, 5kg with abrasive plate, removable chamber & filter

Front

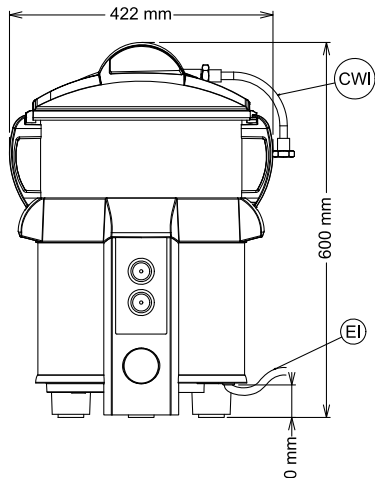

Side

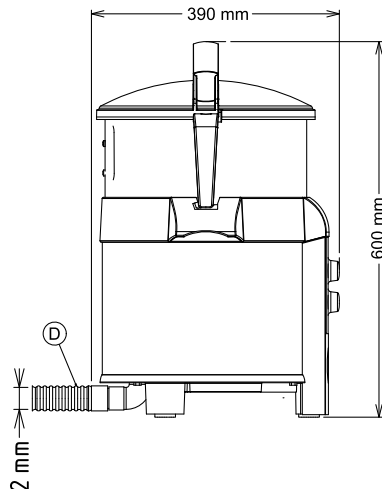

- CWI** = Cold Water inlet 1
(cleaning)
D = Drain
EI = Electrical inlet
(power)

Top

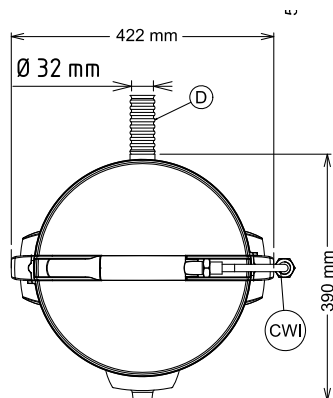

Electric

Supply voltage:

603498 (DT5EFB)

220-240 V/1N ph/50/60 Hz

Capacity:

Performance (up to):

80 kg/hour

Capacity:

5 kg

Key Information:

External dimensions,

Width:

424 mm

External dimensions,
Depth:

390 mm

External dimensions,
Height:

590 mm

Shipping weight:

21 kg



Peelers
Vegetable Peeler, 5kg with abrasive plate, removable chamber & filter
The company reserves the right to make modifications to the products
without prior notice. All information correct at time of printing.

2024.06.08